

# OPERATION MANUAL

## TWE Pin Welder *Model TWP-2*



**TRU-WELD EQUIPMENT COMPANY**

6400 N. HONEYTOWN ROAD

SMITHVILLE, OHIO 44677

(330) 725-7744

Revision 2.0

8/22/2013

## TRU-WELD EQUIPMENT LIMITED WARRANTY

All goods produced by Truweld Equipment shall be warranted against defects including workmanship and components. No other warranties whether expressed, verbal, or implied will apply. Warranties only apply to the original equipment purchaser.

Warranty claims will be limited to either repair or replacement of the defective materials by Truweld Equipment. At the option of Truweld Equipment the location of where the warranty evaluation and repairs are made will be determined. All warranty claim items returned to Truweld Equipment will be at the customer's expense. At the option of Truweld Equipment the defect will either be repaired or replaced. Notice must be provided to Truweld Equipment of a warranty defect within 30 days that the defect or failure is incurred. Warranties are not transferable.

This warranty does not apply for equipment which is used improperly in any fashion including but not exclusive to the following:

Equipment which has been modified

Equipment which has not been installed properly

Equipment which has been used for purposes other than which it had been designed

Equipment which has not been properly maintained

Equipment which was continued to be used after a defect had been found

Equipment which was damaged in any way

Truweld Equipment will never be liable for consequential damages, loss, or expense occurring directly or indirectly from the use of the equipment covered in this warranty.

All cables, cable sets and connectors are not warranted.

Two (2) year warranty period from date of purchase

SC3402 Power Supply      SC3400 Power Supply

SC2420 Power Supply      SC2402 Power Supply

SC2400 Power Supply      SC1900 Power Supply

SC1950 Power Supply      SC1600 Power Supply

SC1650 Power Supply      SC1400 Power Supply

SC1450 Power Supply      SC900 Power Supply

TWE250 Power Supply

TWE321 Power Supply

TWE375 Power Supply

One (1) year warranty period from date of purchase

TWESPC Power Supplies

TWP-2 Power Supply

Ninety Day warranty period from date of purchase

(Excluding cables and connectors)

TWE70000 HD Arc stud gun

TWE18500 MD Arc stud gun

TWE19000 LD Arc stud gun

TWEG CD stud gun

TWEHDG Heavy Duty CD stud gun

# CONTENTS

---

<b>Section</b>	<b>Description</b>	<b>Pages</b>
<b>1</b>	<b>Warranty</b>	<b>2</b>
<b>2</b>	<b>Table of Contents</b>	<b>3</b>
<b>3</b>	<b>Product Features</b>	<b>4</b>
<b>4</b>	<b>Specifications</b>	<b>5</b>
<b>5</b>	<b>External Features</b>	<b>6-7</b>
<b>6</b>	<b>Safety</b>	<b>8-10</b>
<b>7</b>	<b>Setup and Welding</b>	<b>11-15</b>
<b>8</b>	<b>Testing Weld Settings</b>	<b>16</b>
<b>9</b>	<b>Inspecting The Weld</b>	<b>17</b>
<b>10</b>	<b>CD Gun Exploded View</b>	<b>18</b>

# PRODUCT FEATURES

---

## **Model: TWP-2**

The TWP-2 incorporates the latest solid state technology into a compact and rugged, portable CD Pin Welder. This system has the capacity to weld pins (including cupped head pins) up to 10-gauge and CD Studs up to #10.

## **FEATURES**

- Digital DC voltage readout (allows for more accurate and repeatable weld settings).
- Cooling fan for increased efficiency.
- Dial-down DC voltage setting (no need to turn off the unit when resetting to a lower voltage).
- Only 15 amp circuit requirement (unit fused @ 15 amps).
- Power output @ lower DC voltage requirements.
- Terminal connections on the capacitor are over 5/8" in diameter for a good seat on the terminal buss bars to increase reliability.
- The terminal connections on the capacitor have 1/4-28 socket set screws inserted into each one. The socket set screw is used to make the connection to the buss bar. This eliminates damaging the threads in the aluminum connectors of the capacitor, ensuring a solid connection.
- Rigid internal construction connecting the entire internal unit to the front and rear panels minimizes the opportunity of the components coming loose during handling or operations.
- The TWE-Pin Welder is mounted in a rugged outer case for greater durability, texture, and appearance.
- The TWE-Pin Welder weighs in at about 12.5 pounds for ease of carrying.
- Comfortable shoulder strap is optional with the unit.

# PRODUCT SPECS

---

SPECS	TWE-PIN WELDER
SIZE	12.5" L x 10.1" W x 6.0" H 315mm x 255mm x 150mm
WEIGHT	Approx. 12.5 lbs.
WELD RANGE	Weld Pins - Up to 10 gauge CD Studs - Up to #10
DUTY CYCLE	16-20 pins per minute
PRIMARY POWER	110 VAC @ 50/60Hz 15 Amp circuit or 220 VAC @50/60Hz 7.5 Amp circuit
CHARGE VOLTAGE	35-110 VDC

## Operational and Safety Features

- LED Voltage Meter
- Safety Shutdown
- Cooling Fan
- Front-Panel Informational LED's
- Dial-Down weld voltage control

\*\* Specifications are subject to change without prior notification.

# EXTERNAL FEATURES

---

## FRONT PANEL



## TOP OPEN VIEW

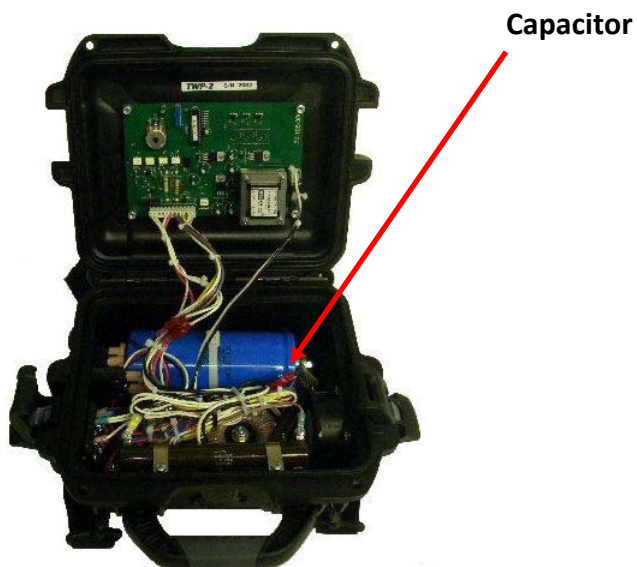

# EXTERNAL FEATURES

---

## SIDE VIEWS



Stud Gun Weld Cable Connection

Stud Gun Control Cable Connection

Ground Cable Connection



ON/OFF Switch

15amp Circuit Breaker

# SAFETY

---

## **PROTECT YOURSELF AND OTHERS!**

Read the safety notices before using welder.



## **ELECTRICAL**

No portion of the outer cover of the welding controller should be removed by anyone other than qualified personnel. Always disconnect the unit from the main power prior to removing cover.

- This equipment contains a transformer power supply system, which is energized by AC current and transforms the AC to DC current. Due to potential dangerous electrical input and output the equipment must be disconnected from all incoming power when servicing.
- Capacitors store electrical energy. Check for residual charge before performing any maintenance.
- Do not use fluids to clean electrical components as these may penetrate the electrical system and cause shorts.

Connection of the unit into service must be in accordance with the setup procedures as detailed in this manual. Operation of this equipment must be in accordance with all local, regional, and national safety codes.



# SAFETY

---

## FIRE

During welding, small particles of hot metal can be expelled. Ensure that no combustible materials are near the welding area.



## PERSONAL SAFETY

Arc rays can burn your eyes and skin. Wear protective clothing and eye protection when welding.

Loud noises from welding can damage hearing. Wear earplugs or other protective gear, if applicable.

Fumes and gases expelled during welding can be hazardous to your health. Make sure welding is done in a well-ventilated area.

Hot metal splatter can cause fires and burns. Wear protective clothing, free of combustible materials. Have a fire extinguisher nearby and know how to use it.

## MAINTENANCE

All cables must be inspected regularly to ensure that no danger exists from worn or damaged insulation or unsafe electrical connections. Take special note to the cables near the stud gun - this is where maximum wear occurs.

Worn cables not only produce inconsistent welds, but can overheat or spark.

# SAFETY

---

## TRAINING

Use of this equipment must be limited to authorized personnel only. They must be adequately trained, and have read and understood everything in this manual. The manual must be available to operators at all times.



## INSTALLATION

Select a site for the equipment which is capable of supporting the weight of the equipment, which is clear from traffic routes where people may trip over cables, or they may be damaged by other equipment or vehicles.

Do not hang connecting cables over sharp edges or have near heat sources.

## DISPOSAL

The equipment, in its entirety or as components/parts may be disposed of as general industrial waste or scrap. None of the components used in the manufacturing of the CD Welders are toxic, carcinogenic, or otherwise harmful to your health.

# SET-UP AND WELDING

---

## CONNECTING THE WELDING LEADS

Connect the stud gun weld cable into the gun terminal socket on the side of the welding unit.

**\*\*\*NOTE** - the cable end plug has a flat which aligns with a dot on the panel mount socket. Secure the connector into the panel mount socket, and then turn it clockwise until it locks into proper position. Failure to do so could result in damage to the connector.

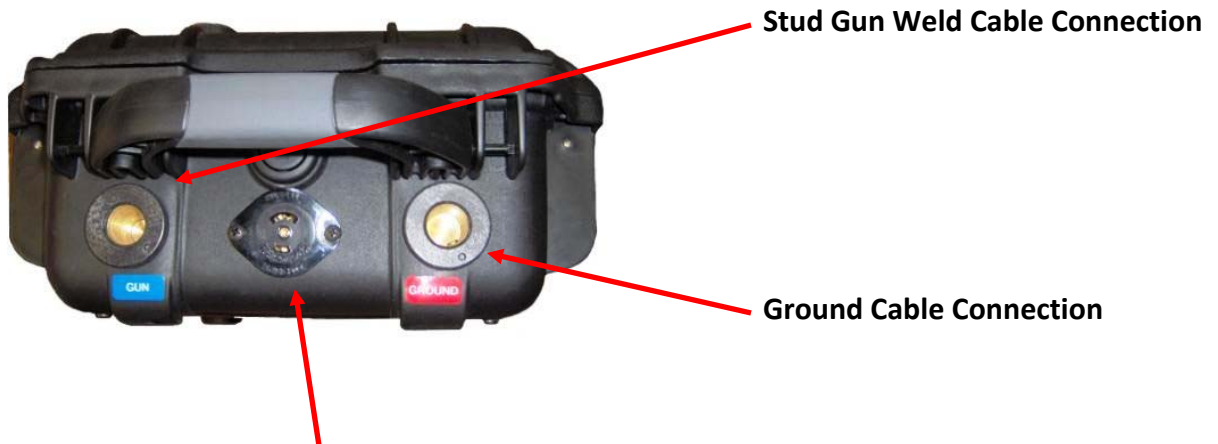

Stud Gun Control Cable Connection

Connect the weld gun control cable into the center panel 2-pin socket.

**\*\*\*NOTE** - the plug has a large pin and a small pin that match the socket on the unit. This is to prevent incorrect connections. Push the plug firmly into the socket and twist clockwise to secure the plug into the correct position.

Connect the Ground Cable into the ground terminal socket on the side of the unit.

# SET-UP AND WELDING

---

## **CONNECTING THE GROUND CLAMP**

Attach the clamp of the welding ground lead to the work piece. Prior to securing the clamp, make certain that the contact area is free of rust, paint, grease, or any other impurities to ensure a good ground connection.



# SET-UP AND WELDING

---

## SELECTING THE PROPER STUD COLLET (STUD HOLDER)

The collet is selected to the proper diameter that you are welding.

There are three styles of collets;

- The “B” collet which is a two-piece assembly (collet and insert). The insert determines how much of the stud is engaged in the collet.
- The CI (Collet Insert) which is a single part and the amount of the stud that is engaged is predetermined.
- Standard Adjustable Chucks have an adjustable internal screw to manually adjust for the engagement of the stud.

The choice between these systems is usually a matter of personal preference.

Inserting the selected collet into the stud gun is a simple task. Place the collet into the front holder of the stud gun and set the locking screws to hold it in place.

After inserting the collet, mount the two legs and foot piece onto the stud gun. The collet should be centered through the opening of the foot piece.

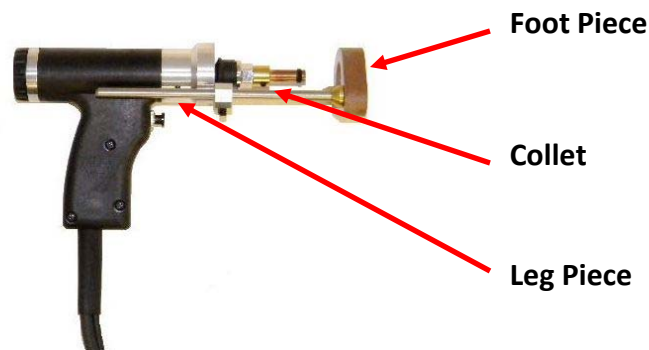

When the legs and foot piece are in place, insert the stud to be welded into the collet. Adjust the leg and foot piece by sliding it into position until approximately 1/8” of the stud protrudes from beyond the foot piece. Lock legs in place with the set screws.

# SET-UP AND WELDING

---

## SELECTING THE SPRING LOAD

The proper spring pre-load setting on the stud gun will vary depending on the selected application. General rules of application would be; mild steel or stainless steel usually in the 1 to 2 range, depending on the stud diameter and the thickness of the base material. Aluminum and other nonferrous metals would require settings from 3 to 5 depending on the diameter of the stud and base material thickness.

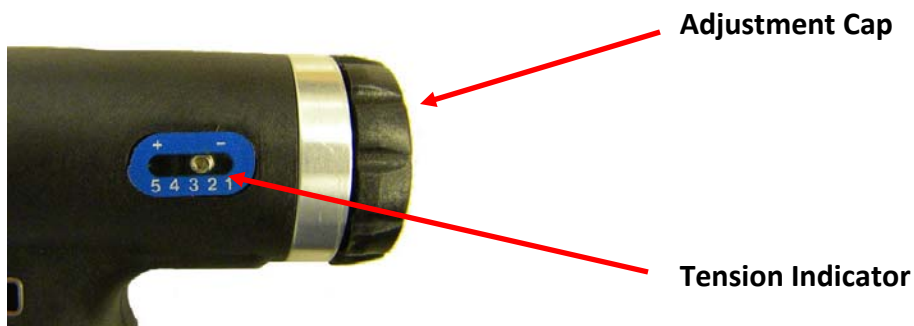

This spring pre-load adjustment is made by turning the adjustment cap on the back of the stud gun. On the bottom of the back cap of the stud gun is the indicator numbered 1 thru 5, which will show you the tension setting during the adjustment.



# SET-UP AND WELDING

## READY FOR WELDING

When you have completed all of the previous steps to prepare for welding, including connecting the stud gun and ground cables to the unit, attaching the ground cable(s) to the work area, setting up and adjusting the stud gun for the selected stud diameter and material, you can now power on the welder.

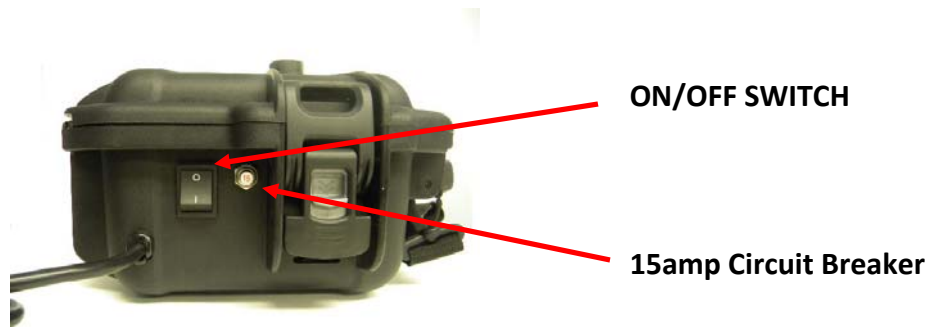

The controller ON/OFF switch is located on the rear of the unit in the upper right hand corner. Below this switch is the 15amp circuit breaker for the system.

## VOLTAGE SELECTION

- Selecting the required weld voltage is achieved by turning the selector knob. The voltage range is from 35VDC to 110VDC.
- The voltage is determined by the diameter of the stud and the base material. The unit is labeled with recommended voltage settings for various applications.
- Fine tuning the voltage to meet your requirement for your specific application is recommended.



# TESTING WELD SETTINGS

---

## TESTING YOUR SETTINGS

When you have performed all of the presets as discussed in this manual, it is recommended that you perform several test welds with the same diameter stud and base material that you will be using. This will verify that all of the settings are correct to the results you desire. Welding is done by placing the stud into the collet, and pressing the stud gun to the work piece, compressing the spring. This is why the stud must protrude beyond the foot piece at least 1/8".

Holding the gun perpendicular to the work piece, and aligning the stud to the desired position on the work piece, press down so that the foot piece is flush with the work piece (spring compressed), and depress the trigger.



When removing the stud gun from the welded stud, always lift the stud gun vertically from the welded stud in order to maintain the proper tension of the collet. Spreading the collet when lifting the stud gun from the welded stud will shorten the life of the collet and will eventually create an undesirable weld.



# SET-UP AND WELDING

---

## INSPECTING THE WELD

Visually inspect the weld. A good weld will result in an all-around weld, with a small visible amount of weld surrounding the flange of the stud. Too much splatter and the weld is too hot, lower the voltage. No splatter and the weld is too cold, increase the voltage.

If you get weld flash to one side of the stud as opposed to an even amount around the base of the flange, this is called “arc blow”, and can be solved by repositioning the ground clamp or using a dual ground clamp.

Proper welded studs can be tested by either torquing or bending the stud. The welded flange of the stud should stay in place using either method, even though the threaded portion of the stud breaks. If the base material is very thin, then a full slug, the diameter of the flange will pull from the base metal for a properly welded stud.

### CD Stud Welding Steps

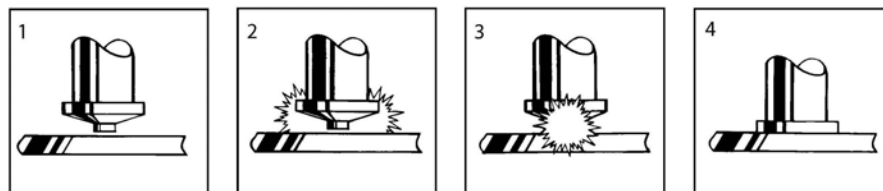

# CD Gun Exploded View

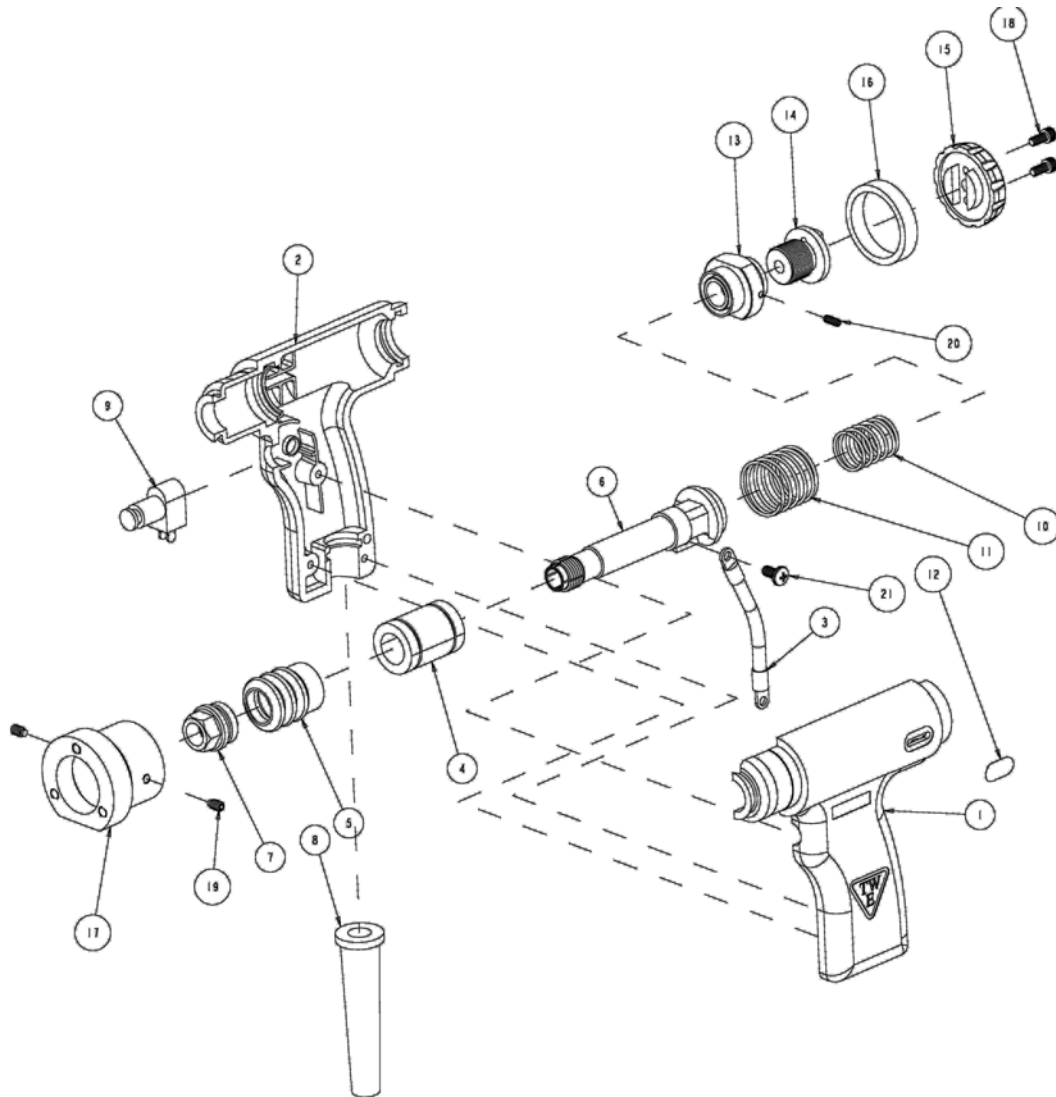

PARTS LIST			
ITEM	QTY	PART No.	DESCRIPTION
1	1	SMG-100L	CD GUN BODY LEFT HALF
2	1	SMG-100R	CD GUN BODY RIGHT HALF
3	1	SMG-101	CD GUN INTERNAL CABLE CONNECTOR
4	1	SMG-102	CD GUN BEARING
5	1	SMG-103	CD GUN BELLOWS
6	1	SMG-104	CD GUN SHAFT
7	1	SMG-105	CD GUN RETAINING NUT
8	1	SMG-106	CD GUN STRAIN RELIEF
9	1	SMG-107	CD GUN TRIGGER SWITCH
10	1	SMG-108	CD GUN SPRING LIGHT COMPRESSION
11	1	SMG-109	CD GUN SPRING HEAVY COMPRESSION
12	1	SMG-110	CD GUN SPRING ADJUSTMENT LABEL
13	1	SMG-111	CD GUN SPRING ADJUSTMENT BLOCK
14	1	SMG-112	CD GUN SPRING ADJUSTMENT SCREW
15	1	SMG-114	CD GUN BACK CAP
16	1	SMG-115	CD GUN LOCKING RING RETAINER
17	1	SMG-117	CD GUN FRONT CAP
18	2	SMG-HDWR-1	#8-32X.375 SOCKET HEAD CAP SCREW
19	2	SMG-HDWR-2	#10-24X.313 HEX SET SCREW
20	1	SMG-HDWR-3	#6-32X.375 HEX SET SCREW
21	1	SMG-HDWR-4	#10-32X.375 CAP HEAD SCREW

19-Sep-12

TRU-WELD Equipment Company

**6400 N. Honeytown Road**

**Smithville, Ohio 44677**

**(330) 725-7744 Phone**

**(330) 669-2473 Fax**

**TWE@tfpcorp.com**

**<http://truweldstudwelding.com>**



**MADE IN THE USA**